

---

**AEG HIGH VOLTAGE BATTERY**

# INSTALLATION MANUAL

**AEG HIGH VOLTAGE BATTERY**

**SERIES:**

**AS-BBH1-10000/HV**

**AS-BBH1-15000/HV**

**AEG**

# AEG HIGH VOLTAGE BATTERY INSTALLATION MANUAL

Thank you for choosing the reliability of AEG high voltage batteries.

This installation manual is intended for dealers and installers involved in the planning, installation and commissioning of photovoltaic systems deploying AEG high voltage batteries. These instructions provide you with valuable information to ensure that your battery runs smoothly over its whole lifecycle.

AEG high voltage batteries are tested and approved by acknowledged independent certification authorities and can only be installed by qualified professional companies.

Please observe the standards and regulations applying to photovoltaic systems in the relevant countries, as well as the rules of the employers' liability insurance associations for accident protection. Failure to comply with these can result in major injuries and damage.

The information provided in this manual is accurate at the time of publication; however, Solar Solutions reserves the right to make changes to product design and technical specification updates at any time without prior notice. Illustrations in this manual are meant to help explain system configuration concepts and installation instructions. The illustrated items may differ from the actual items at the installation location.

Keep this guide in a safe place for further reference as it contains important information for product care, maintenance and disposal.

## CONTENTS

1. PRELIMINARY REMARKS	3
1.1 Icons	3
1.2 Product Identification	3
2. SAFETY	4
2.1 General safety	4
2.2 Handling safety	4
2.3 Installation safety	5
2.4 Grid-tied operation safety	5
2.5 Maintenance safety	5
2.6 Response to emergency situations	6
3. PRODUCT OVERVIEW	6
3.1 General remarks	6
3.2 Product appearance	7
3.3 Technical data	8
3.4 Operating data	8
4. INSTALLATION	8
4.1 Installation tools and materials	8
4.2 Wire specifications	9
4.3 Unboxing	9
4.4 Choosing the installation site	10
4.5 Mechanical and electrical installation	10
5. PRODUCT END OF LIFE	12
6. DISCLAIMER OF LIABILITY	13
7. CONTACT	13

## 1. PRELIMINARY REMARKS

### 1.1 Icons

This section describes relevant warning symbols recurring in the installation and operation manual of AEG high voltage batteries. Icons highlight relevant information for the physical and property safety of the user. Compliance to the provided instructions is essential to prevent physical injury and product damage. Below is a list of the icons used in this manual:





Icon	Meaning	Instruction
	Danger	Serious physical injury or even death may occur in case of noncompliance with the requirement (electrical hazard)
	Warning	Physical injury or product damage may occur in case of noncompliance with the requirement.
	Electrostatic discharge	Damage may occur in case of noncompliance with the requirement.
	Hot surface	Product surface may become hot, do not touch
	Note	Useful information for product maintenance and operation is provided

Table 1: Icon meaning

### 1.2 Product Identification

#### High Voltage Battery:

Each High Voltage Battery can be identified by means of the following information:

#### Serial Number

Each battery is identified by a unique serial number univocally coupled with a barcode, to be found on the housing.











#### Product Label

The product label of the battery pack is placed on the housing. It provides information about the main parameters of the device such as: Product Name Code (PNC), Battery Type, Capacity, Nominal Voltage and Nominal Energy, Charge, and further operation parameters.

<b>AEG</b>		
<b>PRODUCT NAME CODE: AS-BBH1-10000/HV</b>		Solar Solutions BV Finlandaan 1 2391PV Hazerswoude-Dorp The Netherlands www.aeg-industrialsolar.de info@aeg-industrialsolar.de
Li-ion Battery Pack	Rechargeable Li-ion	
Capacity: 40 Ah	Nominal voltage: 268.8VDC	
Nominal energy: 10kWh	Usable energy: 9 kWh	
Charge/discharge current (nominal): 20A/20A		
Operating temperature range: -10-50°C		
Protective Class: Class I		
IP54	IFpR/41/136/(2P84S)M/-10+50/NA	
		

Label example

Explanation of icons on product label:

Icon	Meaning
	Safety warning: electrical hazard
	Electrolytes leak danger
	Risk of explosion
	Heavy, handle with care to avoid injury
	Keep away from fire or ignition sources
	Keep away from children
	Ensure correct polarity connection
	For proper use read the installation manual
	Suitable for recycling through a professional battery recycling company
	CE marking. The product complies with the CE directives
	EU WEEE mark. Do not dispose of product as household waste.

Explanation of icons on battery label

Please refer to the specific product datasheet on [www.aeg-industrialsolar.de](http://www.aeg-industrialsolar.de) for the latest technical data.

## 2. SAFETY

### 2.1 General safety

All AEG high voltage batteries are tested according to international safety regulations.





AEG high voltage batteries should be installed, maintained, connected and operated by qualified technicians in compliance with all local and national applicable standards, codes and regulations issued by the relevant power suppliers, companies and authorities. Installers bear the risk of all injury that might occur during installation including, without limitation, the risk of electric shock. Check and follow all safety precautions specified even for the other components of the system. Keep children away from the installation site and during transportation, installation and maintenance of the electrical equipment.

### 2.2 Handling safety

Please observe the following indications when handling the AEG high voltage battery.

Look for any visible damage to the package or the product itself. Double-check the order information and the product nameplate to ensure the products are of the ordered type. Check that the package contents are not damaged and that all items listed are present (see 4.5 „Unboxing and package content“). Should you find any issues, contact the shipping company and / or your supplier as soon as possible before attempting product installation.

Take note of the indications displayed on the product packaging. Specifically:

Icon	Meaning
	This side up
	Fragile
	Handle with care
	Do not turn or drop
	Do not stack

Icon	Meaning
	Keep dry

Packaging icon meaning

 Please make sure that the high voltage battery and its components are properly packed and sealed to ensure safe transportation. Ensure that the battery pack is stored in a dry, clean place and not exposed to water or dust.

 The battery pack is heavy. Handle it carefully in order to avoid injuries. At least two people are required to move and install the battery pack.

To ensure handling, installation and maintenance safety, and to avoid personal injuries, please adopt mechanical protective measures such as wearing protective shoes and work clothes.

 To avoid electric shock, remove metallic rings, watchbands, ear, nose or lip rings or other metallic devices during installation, connection and maintenance of the high voltage battery.

#### 2.2.1 Handling the battery pack

 Handle the battery pack carefully as it may leak corrosive electrolyte.

 To avoid the risk of explosion of the battery pack, make sure to observe the following:  
Do not make the battery pack undergo strong impacts.  
Do not crush or puncture the battery pack.  
Do not dispose of the battery pack in a fire.

 To avoid fire risks to the battery pack, please make sure to observe the following:  
Do not expose the battery pack to temperatures that exceed 60°C.  
Do not place the battery pack near a heat source, such as a fireplace.  
Do not expose the battery pack to direct sunlight.  
Do not allow the battery connectors to touch conductive objects such as wires.

 To avoid the risk of the electric shock from the battery pack, please make sure to observe the following handling instructions:  
Do not disassemble the battery pack.

Do not touch the battery pack with wet hands.  
Do not expose the battery pack to moisture or liquids.  
Keep the battery pack away from children and animals.

To avoid damaging the battery pack, please make sure to also observe the following handling instructions:  
Do not allow the battery pack to come in contact with liquids.

Do not expose the battery pack to high pressures or strong forces.

Do not place any objects on top of the battery pack.  
Do not pull or drag the battery pack, nor step on it.

### 2.3 Installation safety

Installing solar photovoltaic systems and batteries requires specialized skills and knowledge and can only be performed by qualified technicians (see 2.1 General safety). All electric installations need to comply with the national and local laws and standards.

Use the AEG high voltage battery pack only for the intended purpose in combination with the suitable AEG hybrid inverter.

 For installation, choose a location out of the reach of children or public access. Keep the battery pack away from the reach of children.

 Ensure you are completely familiar with the indications provided the instructions manual before attempting installation.

 Do not use the battery pack if it is defective, if it appears to be cracked, broken or otherwise damaged, or if it fails to operate.

 Handling or changing components without following the instructions in this manual may cause personal injury, cause product damage, and ultimately void the warranty.

 Do not attempt to open, disassemble, repair, or modify the battery pack. The battery pack can only be repaired by AEG service personnel.



Use only installation equipment suitable for a solar electric installation.

 Only use original parts and components.

Handle with care to avoid damages to the battery pack and its components during transportation.

 Installers and operators should carefully follow the instructions in this manual when handling the high voltage battery and avoid hazardous actions that might result in life-threatening situations.

 It is important to ensure proper grounding according to local requirements.

  Do not install the battery pack on or close to flammable or explosive materials.

Do not insert any foreign objects into any part of the battery pack.

Do not use cleaning solvents to clean the battery pack.

### 2.4 Grid-tied operation safety

Only qualified electricians are allowed to operate the high voltage battery under the permission of local energy authorities.

All electrical connections must meet the electrical standards of the country/region in which the installation is located.

Ensure reliable installation and electrical connection before operation.

 Make sure that the battery polarity is connected correctly.

 Do not open the high voltage battery cover.

### 2.5 Maintenance safety

Only qualified professionals are allowed to carry out maintenance, inspection and refitting of the AEG high voltage battery. If your AEG high voltage battery requires maintenance, please contact your supplier.

Ensure that unauthorized people do not access the maintenance area during maintenance operations.

 Before attempting maintenance, disconnect first all power supplies from the grid to the energy storage system. Disconnect the breakers. Wait at least 5 minutes until the internal parts of the system are discharged.

 Please follow the electrostatic protection norms, and take correct protective measures as there are electrostatic sensitive circuits and devices in the system. Appropriate protective measures are meant to prevent damages to the product and personal injury.

 Only use original parts and components. Do not refit the energy storage system unless authorized.

 Do not get near to / touch any metal conductive part of the grid or of the high voltage battery, otherwise electric shock, physical injury, death or fire may occur. Always pay attention to warning icons and instructions signaling the possibility of electric shock.

Do not use cleaning solvents to clean the battery pack.

## 2.6 Response to emergency situations

The battery pack is designed to prevent hazards resulting from failures. However, Solar Solutions cannot guarantee for its absolute safety.

 If the battery pack leaks electrolyte, avoid contact with the leaking liquid or gas. Electrolyte is corrosive and contact with it may cause skin irritation and chemical burns.

If you find yourself in any of the below emergency situations resulting from exposure to electrolyte, please take the suggested take promptly:

**Inhalation:** evacuate the contaminated area, and immediately seek medical attention.

**Eye contact:** rinse the eyes with flowing water for 15 minutes, and immediately seek medical attention.

**Skin contact:** wash the affected area thoroughly with soap and water, and seek immediately medical attention.

**Ingestion:** induce vomiting, and seek immediately medical attention

**Fire:** in case of fire, always have an ABC or carbon dioxide extinguisher at hand.

 The battery pack may catch fire if heated above 150°C. If a fire breaks out when the battery pack is installed, proceed with the following actions:

- Extinguish the fire before the battery pack catches fire.
- If it is impossible to extinguish the fire but you still have time, move the battery pack to a safe area before it catches fire.
- If the battery pack has caught fire, do not try to extinguish the fire. Evacuate people immediately.

 If the battery catches fire, it will produce noxious and poisonous gases. Do not get close to it.

**Wet battery:** if the battery pack is wet or submerged in water, do not try to get close to it. Contact your installer/ dealer for technical assistance.

**Damaged battery:** damaged batteries are dangerous and must be handled with extreme caution. They are not fit for use and may pose a danger to people or property.

If the battery pack seems to be damaged, pack it in its original container, and then return it to your installer or distributor.

 Damaged batteries may leak electrolyte or produce flammable gas. If you suspect such damage, immediately contact your installer/ dealer for advice and information.

## 3. PRODUCT OVERVIEW

### 3.1 General remarks

The **AEG high voltage battery AS-BBH1-xxx-/HV (xxx= 10000 or 15000)** is a lithium battery product with BMS (Battery Management System) developed for use with photovoltaic installations.

Characterized by high energy density and reliability, the battery pack's safety is granted among others by relevant protection functions such as under-voltage, over-voltage, over-current, over-temperature, under-temperature protection. The battery pack further supports CAN communication and features a WiFi connection module. The number of battery units can be

expanded (with the use of a Control Box AEG AS-BAC1-4W/HV).

The AEG high voltage battery can be deployed in back-up power systems, micro-grids and home energy storage systems.

### 3.2 Product appearance

#### 3.2.1 High voltage battery

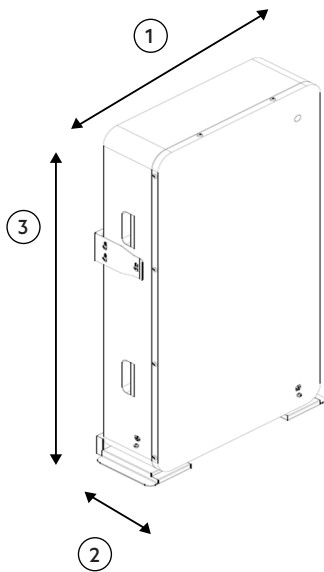

Item	Description	Size	
		AS-BBH1-10000/HV	AS-BBH1-15000/HV
1	Width	654 mm	
2	Depth	227 mm	
3	Height	971 mm	1205 mm
/	Weight	105 kg	143 kg

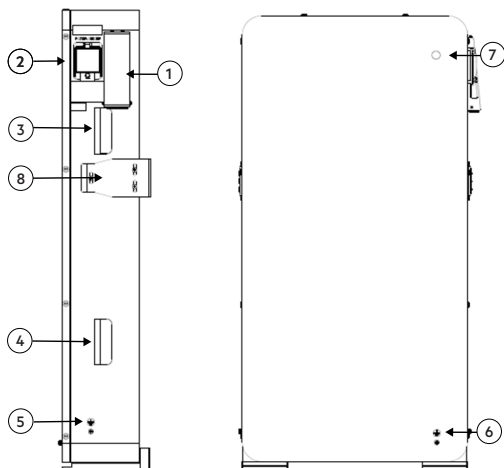

Item.	Description
1	Cable entry
2	Power ON/OFF
3	Handle
4	Handle
5	Grounding
6	Grounding
7	Power light
8	Fixed bracket

#### 3.2.2 Wiring port

The wiring port can be seen in detail after opening the cover plate.

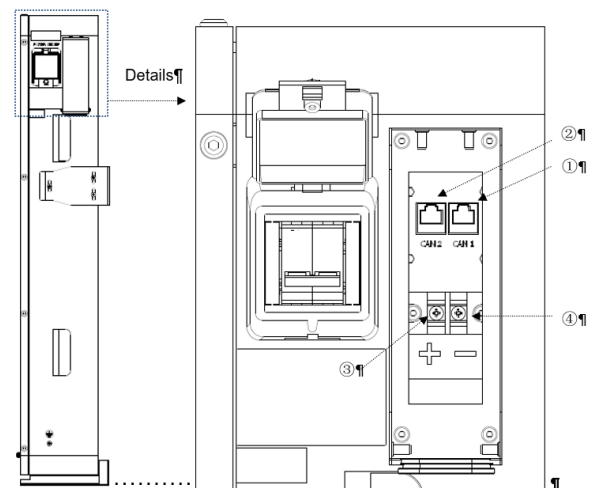

Item.	Description
1	CAN 1 port
2	CAN 2 port
3	Battery + / positive battery pole
4	Battery - / negative battery pole

#### 3.2.3 CAN communication interface (CAN1 & CAN2)

Below is the scheme of the CAN communication interface.

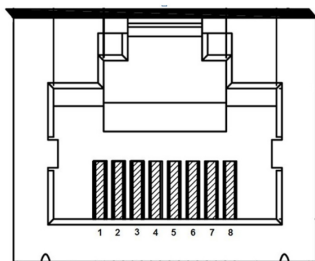

CAN1 port (for inverter communication)

1	2	3	4	5	6	7	8
--	--	--	CAN1H	CAN1L	--	--	--

CAN2 port (for battery communication)

1	2	3	4	5	6	7	8
485A	485B	GND	CAN1H	CAN1L	+12V	CAN2H	CAN2L

### 3.3 Technical data

Technical data of battery module

Electrical characteristics			
Model: AS-BBH1-xxx/HV	xxx=	10000	15000
Battery type		LFP	
Total energy capacity	[kWh]	10	15
Usable energy capacity	[kWh]	9	13.5
Battery capacity	[Ah]	40	40
Voltage range / usable..v.r.	[V]	235.2~294	336~420
Nominal voltage	[V]	268.8	374
Charge current	[A]	294	420
Discharge cut-off voltage	[V]	235.2	360
Charge/Discharge Current (Nominal)	[A]	20/20	
Charge/Discharge Current (Max)	[A]	40/40	
Max. continuous discharge current	[A]	50	
DOD		90%	
Cycle life at 25°C (under standard charge conditions, charge 0.2°C, discharge 0.2°C)		≥6000	
DC disconnect		Contactor Fuse	

Number of expandable battery units	[pcs]	max. 8
<b>Warranties</b>		
For the latest warranties please refer to: <a href="http://www.aeg-industrialsolar.de">www.aeg-industrialsolar.de</a>		

### 3.4 Operating data

#### BMS (Battery Management System)

Power consumption (work)	[mA]	≤100
Power consumption (sleep)	[mA]	≤0.1
Communication	CAN	
Monitoring parameters	System voltage, system current, cell voltage, cell temperature	

#### Operating conditions

Installation Location		Indoor conditioned
Operating Temperature	[°C]	-10~50
Operating Temperature (Recommended)	[°C]	15~30
Storage Temperature	[°C]	-30 ~60
Humidity	[%]	5~95
Altitude	[m]	Max. 2000
Cooling		Natural convection

#### Reliability and certification

Certificates (cell)	UL1642
Certificates (battery module)	IEC62619 / UL1973
Transportation	UN38.3
Ingress rating	IP54

## 4. INSTALLATION

### 4.1 Installation tools and materials

Please ensure you have the following items at hand before beginning the installation of the AEG high voltage battery:



Item	Description
	Tape measure
	Phillips-screwdriver
	Crimping tool
	Wire cutters
	Wire strippers
	Safety (insulated) gloves
	Safety goggles
	Dust mask
	Safety shoes

Use properly insulated tools to prevent accidental electric shock or short circuits.

The below installation material should be arranged by the installer for the installation of the battery pack:

- Charging cables
- Network cable
- DC breaker

#### 4.2 Wire specifications

In order to standardize the wiring specifications of the AEG high voltage battery AS-BBH1-xxx/HV (xxx= 10000 and 15000) please make sure to follow the below requirements for the connecting wires:

Battery cable	Communication cable
Recommended: 8 AWG / 10mm <sup>2</sup> conductor with double insulation	Recommended: standard communication cable with shielding function

#### 4.3 Unboxing

 Due to its weight, the AEG high voltage battery needs to be handled by two or more people.

Before installing the product, please carry out a first check of the package and the package content as described in 2.2 „Handling safety“.

Below is a sketch of the packing box of the AEG high voltage battery.

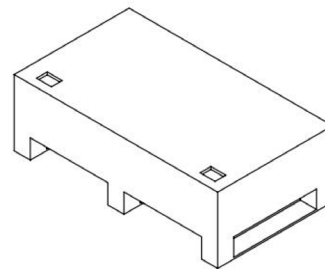

**Step 1:** Open the packing box, take out the wall bracket and remove the EPE plate .

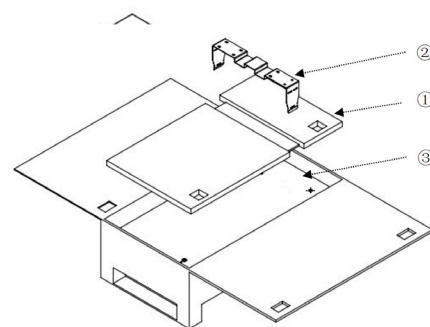

Item.	Description
1	EPE plate
2	Wall bracket
3	AEG high voltage battery

**Step 2:** Pull out the battery pack and stand it upright. Check if the battery pack is damaged.

**Step 3:** All the other items are contained in a box in one corner of the carton. Take them out and check if any item is missing. Keep the carton for future storage or transportation.

#### Battery pack package content

The package content of the AEG battery pack includes the following items. If any item is missing, please contact your AEG distributor.

Item	Name	Qty.
1	Battery pack AS-BBH1-10000/HV or AS-BBH1-15000/HV (according to your order)	1
2	PE wire	1
3	Allen wrench (M2.5)	1
4	M4 socket head combination screws	4
5	M6 Phillips head three combination screw	10
6	M8 expansion screw combination	8
7	Wall bracket	1
8	CAN communication wire	1
9	User manual	1

#### 4.4 Choosing the installation site

**i** Note: For specific requirements such as the narrowest maintenance channel, escape route, etc., please refer to the applicable standards of the country/ region where the project is located.

Please make sure that the installation location meets the following requirements:

- The installation site should be well ventilated and sheltered from direct sunlight, rain and snow;
- The building is designed to withstand earthquakes
- The location should not be in proximity of the sea, to avoid salt water and humidity.
- Ensure there are no corrosive gases at the installation site, including ammonia and acid vapor.
- Ensure there are no flammable or explosive materials at the installation site or nearby.

- The floor of the installation site must be dry and flat. Under no circumstance there should be water on the ground in proximity of the energy storage system. Ensure that the ground level is levelled and can fully carry the weight of the high voltage battery.
- The installation site should be clean.
- Ensure enough clear space to provide space for installation, maintenance, and safe escape.

**i** Note: If the ambient temperature is outside of the operating range, the battery pack will go in self-protection mode and stop operating. The optimal temperature range for the battery pack to operate is between 15°C and 30°C degrees. Frequent exposure to harsh temperatures may deteriorate the performance and lifetime of the battery pack. For this reason, it is recommended that temperature and humidity stay at a constant level.

The AEG high voltage battery should be installed against a wall.

#### 4.5 Mechanical and electrical installation

**Step 1 - Unboxing:** Unbox the AEG high voltage battery, put it upright and check for any damage before proceeding to installation (see 2.2 „Handling safety“ and 4.4 „Unboxing“).

**Step 2-Drilling, Fixing:** install the AEG high voltage battery against the wall. Eight holes should be drilled on the wall in order to fix the racks of the battery module. Please see below picture for details:

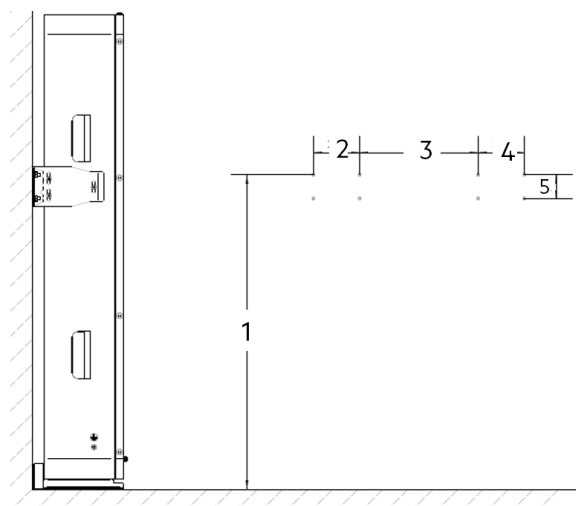

**AS-BBH1-10000/HV**

Item	Distance (mm)
1	572
2	116
3	298
4	116
5	60

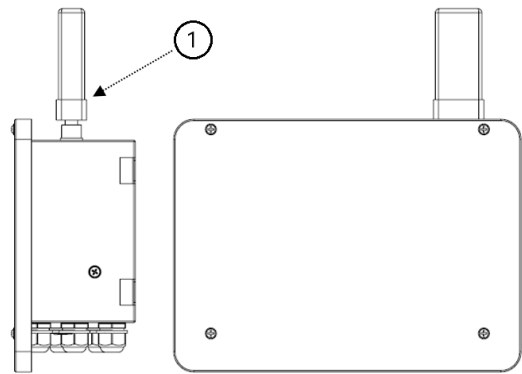

**AS-BBH1-15000/HV**

Item	Distance (mm)
1	796
2	116
3	298
4	116
5	60

Item	Remark
1	WiFi installation position

Remarks: You can find the user manual of the WiFi module in the WiFi packing box. In pure off-grid case when the first installation is completed, if there is no PV power, long press the battery main switch to start the system.

**Step 3-WiFi installation (if applicable):** Insert the WiFi module according to the system configuration: single battery unit or battery units connected in parallel, for details see below:

**Single battery unit:**

The Wi-Fi module should be connected to the CAN2 port of battery with Wi-Fi cable. Please see the below figure for details.

**Step 4 - Connecting the inverter:** Connect the inverter and battery module with the communication and battery cable. Turn on the breaker placed on the right side of the AEG high voltage battery. Please refer to the below figure for details.

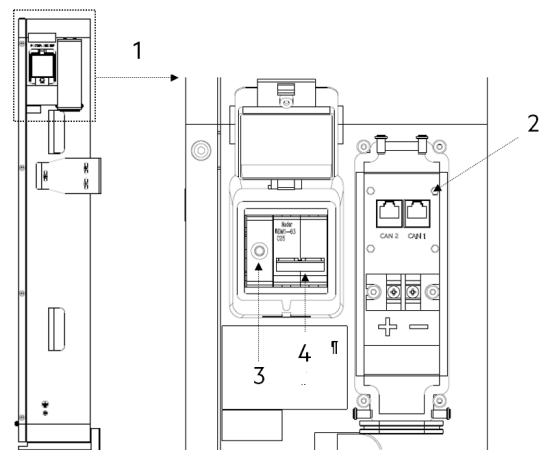
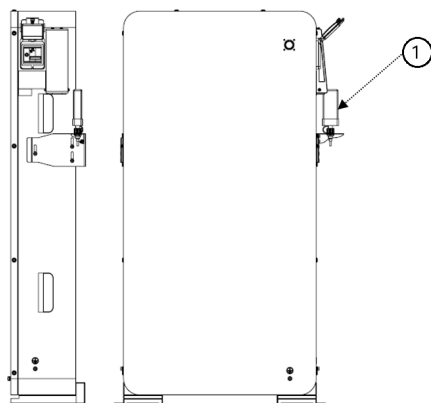

Item	Remark
1	WiFi installation position

Item.	Description
1	Details
2	CAN1
3	Black start
4	Breaker

**Battery units connected in parallel:**

You only need to install 1 Wi-Fi module on the Control Box AEG AS-BAC1-4W/HV. Please see the below figure for details.

CAN1 is connected to inverter for communication. The AEG high voltage battery can only operate after

receiving the inverter’s communication instructions. After the system is powered on, you need to select the battery communication protocol on the inverter, so that the system can run normally.

**Step 5 - Electrical connection of the battery pack**

For connection of a single battery pack:

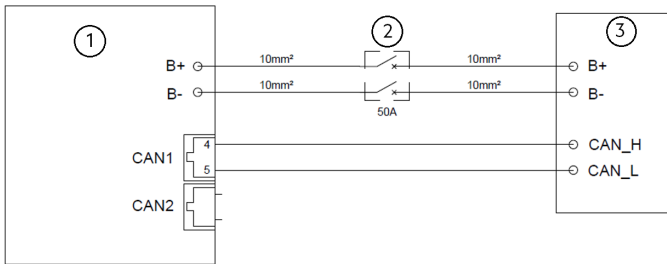

Item.	Description
1	Battery pack
2	Breaker
3	Inverter

For connection of multiple battery packs in parallel:

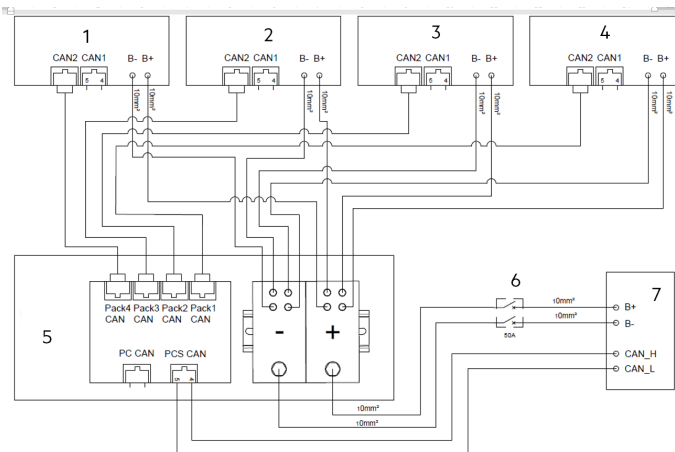

Item.	Description
1,2,3,4	Battery pack
5	HV Pack Parallel Box
6	Breaker
7	Inverter

**Step 6- DOD setting of the inverter** To make sure the battery working smoothly, we recommend the DOD setting of inverter as follows.

- On-grid DOD: 80%
- Off-grid DOD: 70%

**5. PRODUCT END OF LIFE**

Please return any electrical equipment that you no longer use to the collection points provided for their disposal. Information concerning where the equipment can be disposed of can be obtained from your local authorities.



The battery pack is suitable for recycling through a professional battery recycling company



The wheeled bin symbol on the AEG product labels means that the equipment shall be disposed of as special waste in accordance to the local regulations.

**6. DISCLAIMER OF LIABILITY**

The use of this manual and the conditions or methods of installation, operation, use and maintenance of this product are beyond Solar Solutions’s control. Solar Solutions expressly disclaims liability for loss, damage, or expenses arising out of or in any way connected with such installation, operation, use or maintenance.

Solar Solutions will not be responsible for consequences caused by any of the following events:

- Damage caused by transportation.
- Storage conditions do not meet the requirements specified in the manual, resulting in product damage.
- Incorrect storage, installation, and use of the product.
- Product installation and operation performed by unqualified personnel.
- Failure to comply with the operation instructions and safety precautions set forth in this manual.
- Product installation or operation in extreme environments that are not covered in this manual.
- Product installation or operation in environments not specified in the related international standards

- 
- Exceeding the operation range of the parameters listed in the product's technical specifications.
  - Unauthorized product disassembly and modification, or modification of the product's software.
  - Product damage caused by abnormal natural events (force majeure, such as lightning strikes, earthquakes, fires, storms, etc.)
  - Warranty expiration without extension of the warranty period.

No responsibility is assumed by Solar Solutions for any infringement of patents or other rights of third parties which may result from the use of this product. No license is granted by implication or otherwise under any patent or patent rights.

## **7. CONTACT**

**Solar Solutions BV**  
**Finlandlaan 1**  
**2391PV Hazerswoude-Dorp, The Netherlands**  
**[www.aeg-industrialsolar.de](http://www.aeg-industrialsolar.de)**  
**Mail: [service@aeg-industrialsolar.de](mailto:service@aeg-industrialsolar.de)**

AEG is a registered trademark used under license from AB Electrolux (publ).



Solar Solutions Products BV  
Finlandlaan 1 2391PV Hazerswoude-Dorp The Netherlands  
service@aeg-industrialsolar.de | www.aeg-industrialsolar.de

AEG is a registered trademark used under license from AB Electrolux (publ).